

# Integrated Retail and Wholesale (IRW) Power Market Operations

Systems Economics Subcommittee Panel

*Coordinated Operation of Retail & Wholesale Power Markets*

IEEE PES GM 2013

**Auswin G. Thomas, Leigh Tesfatsion, & Dionysios C. Aliprantis**

Iowa State University, Ames, Iowa

# Presentation Outline

- Integrated **R**etail & **W**holesale (**IRW**) Power System Test Bed  
<http://www.econ.iastate.edu/tesfatsi/irwprojecthome.htm>
  
- Topics under study: IRW effects of
  - (1) stochastic Security-Constrained Unit Commitment (SCUC)
  - (2) variable (non-dispatchable) generation
  - (3) price-responsive demand
  
- Illustrative findings for topic (3)

# IRW Test Bed

## 5-Bus 1-Feeder Example:

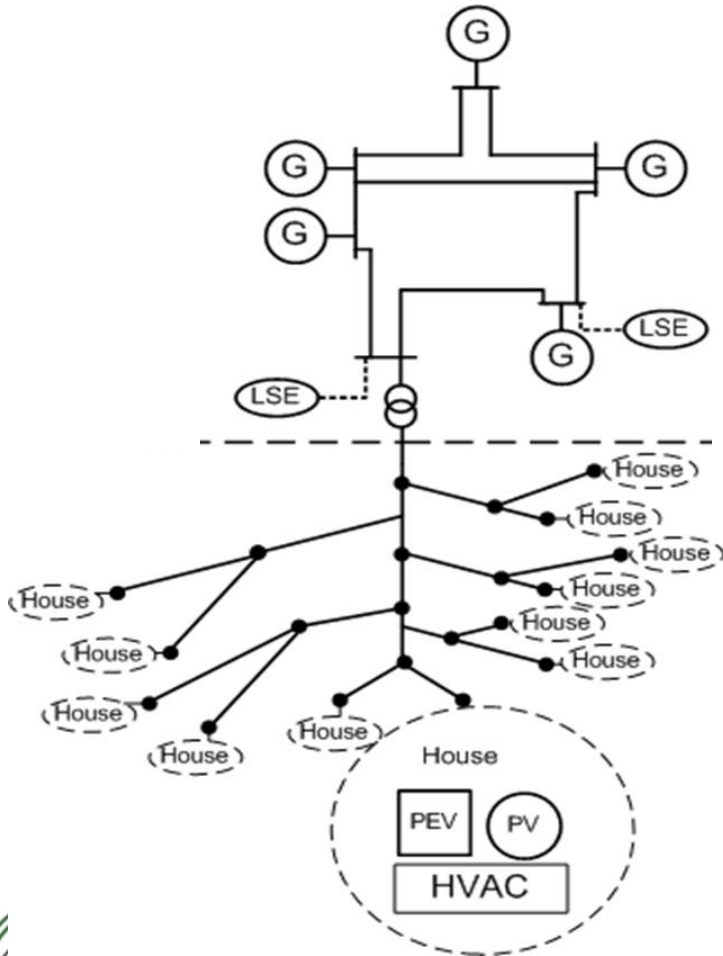

## AMES Test Bed

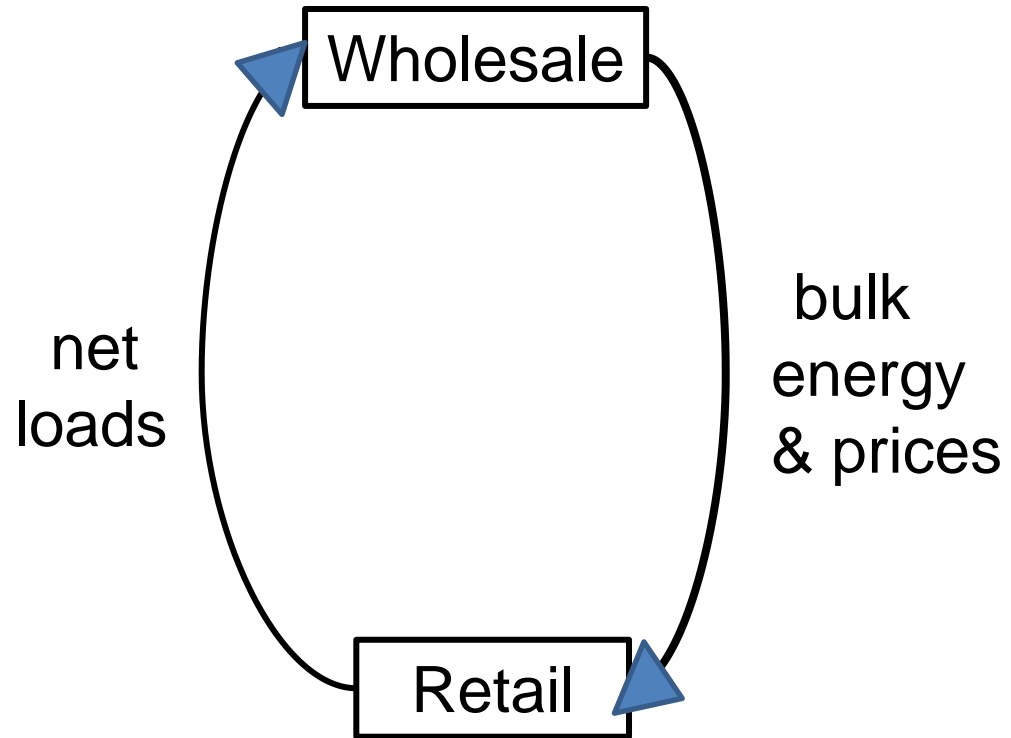

## Distribution Test Feeders

# AMES Wholesale Power Market Test Bed

- **AMES** = **A**gent-based **M**odeling of **E**lectricity **S**ystems
- AMES(V2.06) released as open-source software under GPL  
[www.econ.iastate.edu/tesfatsi/AMESMarketHome.htm](http://www.econ.iastate.edu/tesfatsi/AMESMarketHome.htm)
- Agent-based platform (Java/Python/Pyomo)
- Simulates ISO-managed wholesale power market over AC grid
- Agents include
  - **Decision-making entities** (ISO, GenCos, LSEs,...)
  - **Institutions** (day-ahead market, real-time market, regulations, ...)
  - **Physical structures** (AC transmission grid, loads, ...)
- Events driven by agent interactions, starting from initial conditions

# Activities of AMES ISO during a typical day D-1

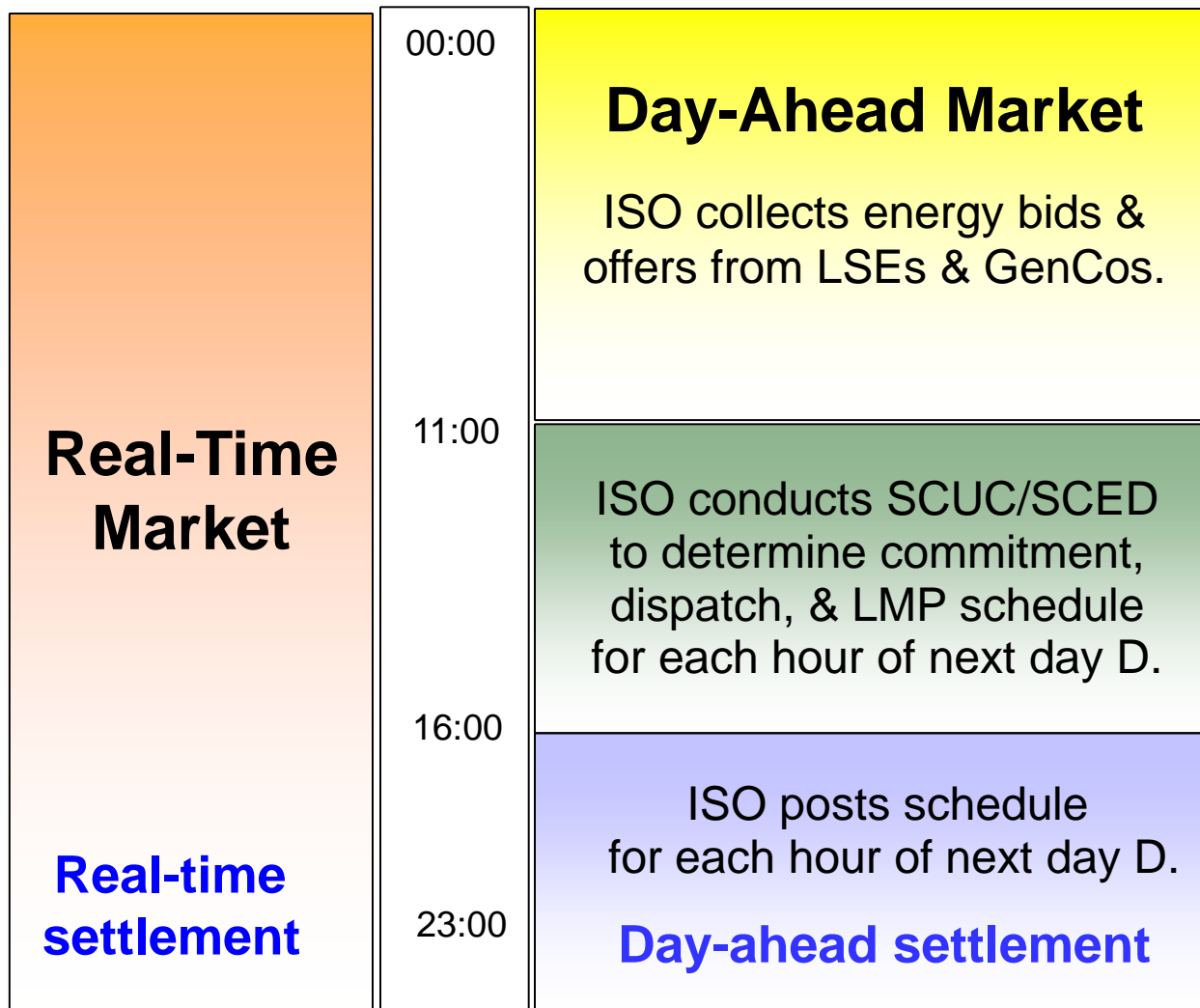

# IRW Feedback Loop

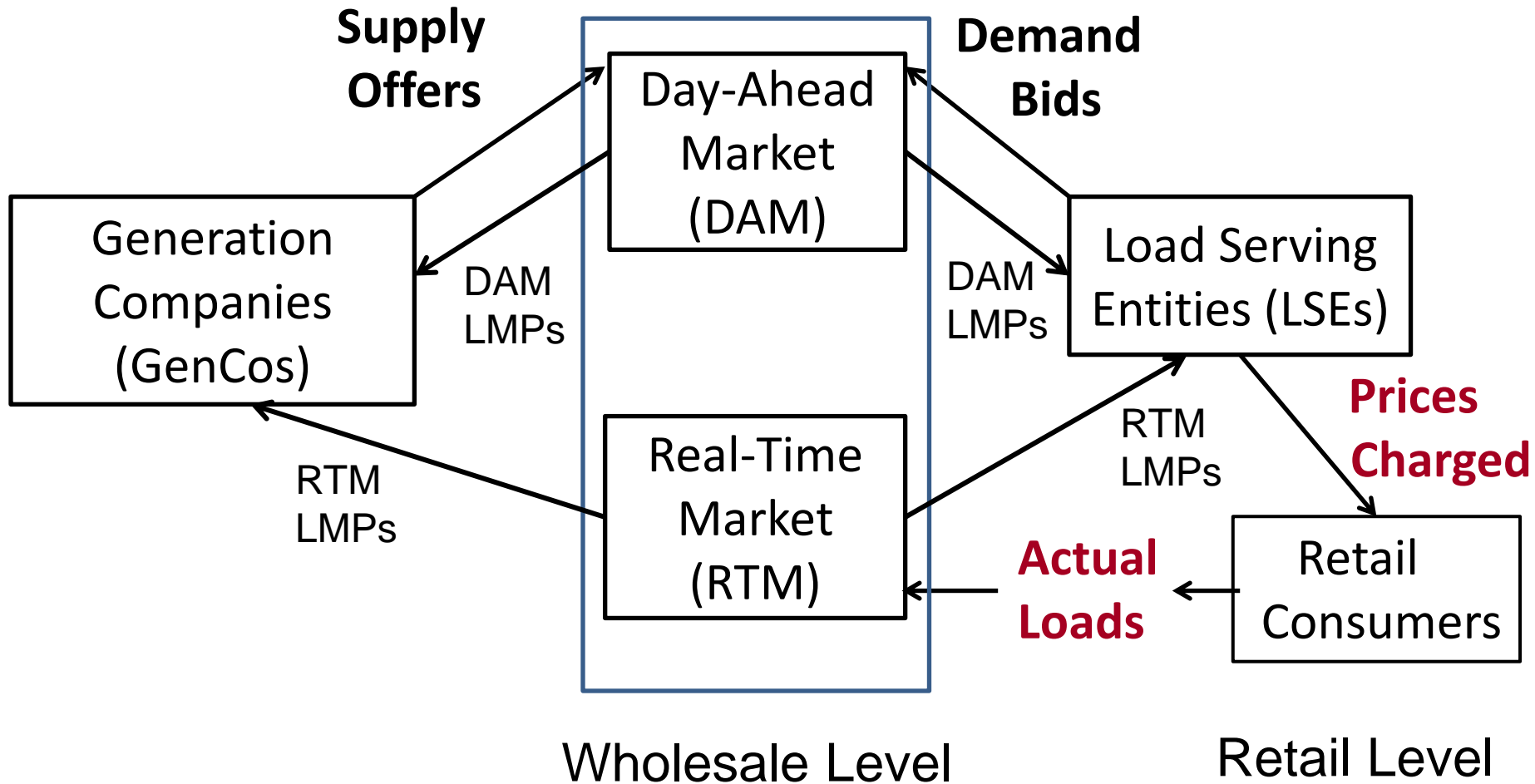

# Price-Responsive Demand: Illustrative A/C Case Study

- An intelligent A/C system controller for households has been developed
- Solves for optimal 24-hour comfort/cost tradeoffs, given anticipated prices & environmental conditions
- IRW Test Bed is being used to study IRW effects when some households have intelligent A/C system controllers

# Intelligent A/C Controller



## Household Preferences

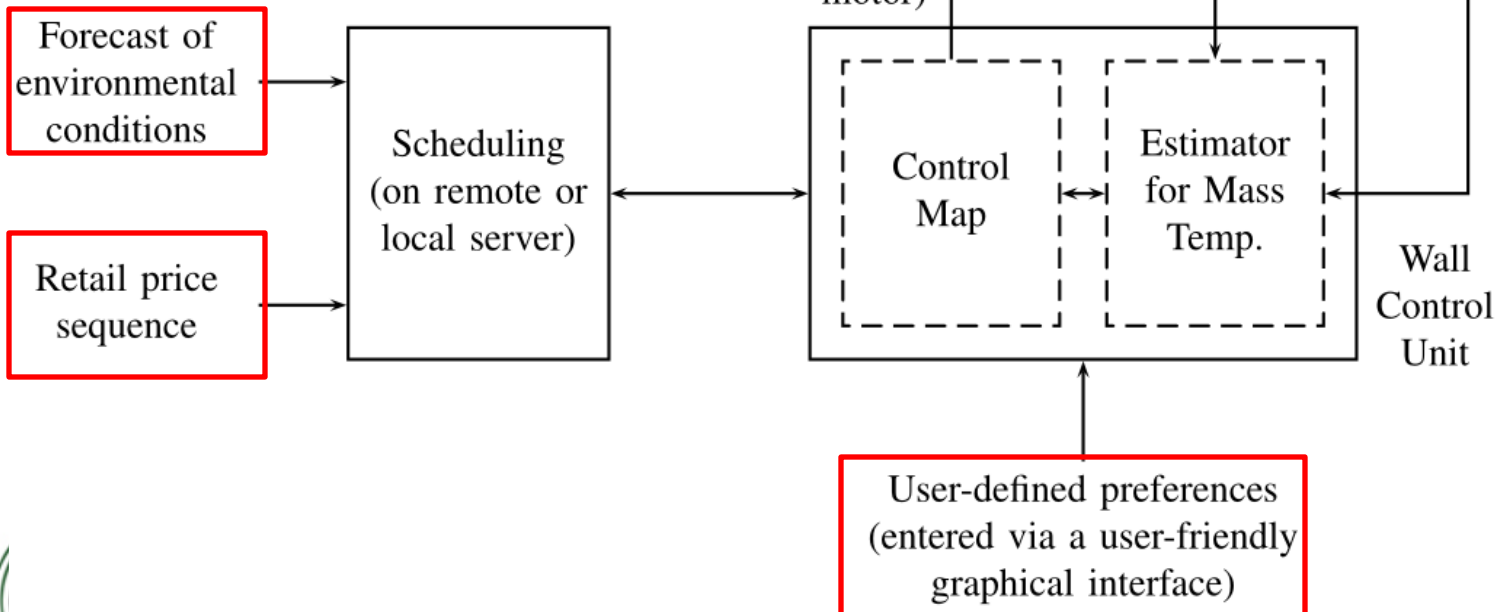



# IRW Test Bed Implementation of Case Study

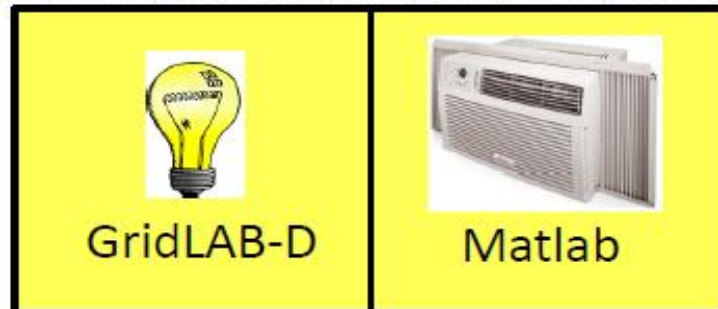
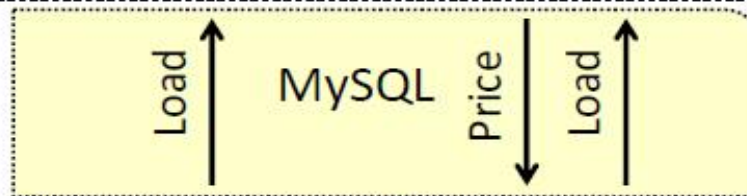
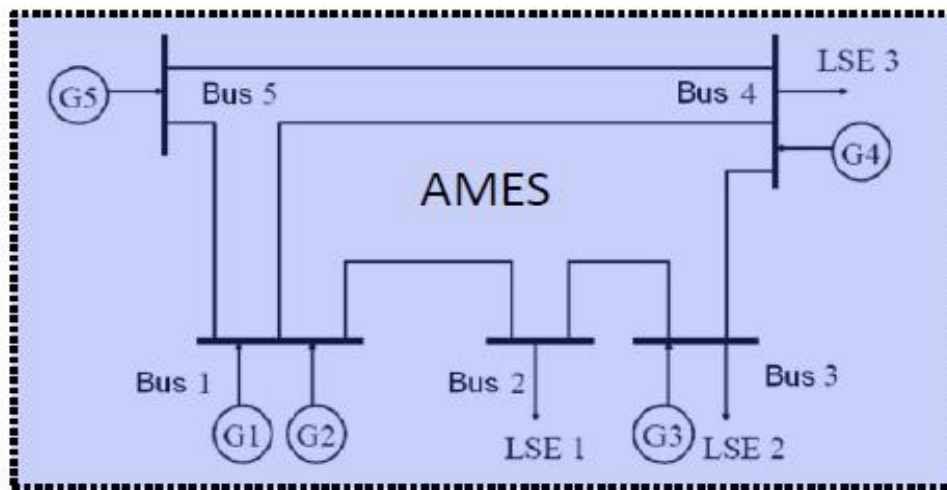

Conventional Load

A/C Load



Modeling of Households

# Environmental Forcing Terms

Outside Temperature (°F)

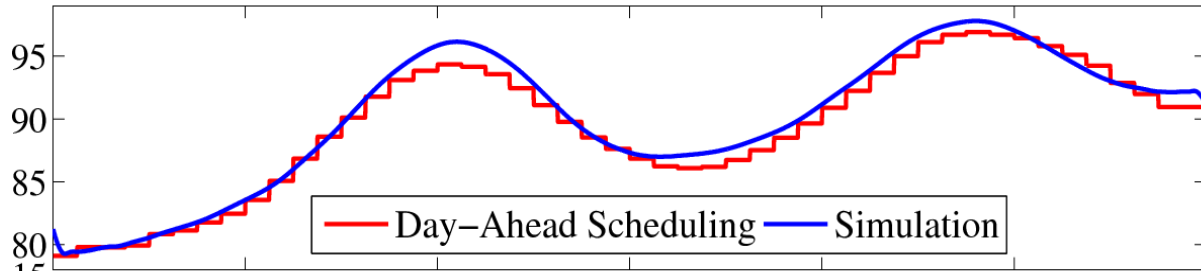

Solar Heat Flow Rate (kBTU/h)

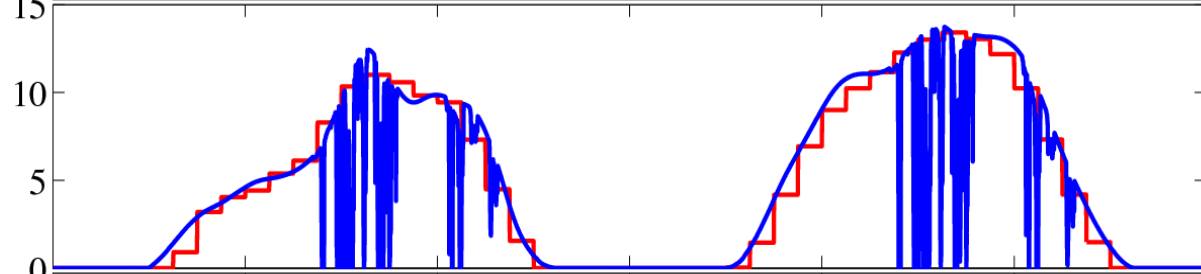

Internal Heat Flow Rate (kBTU/h)

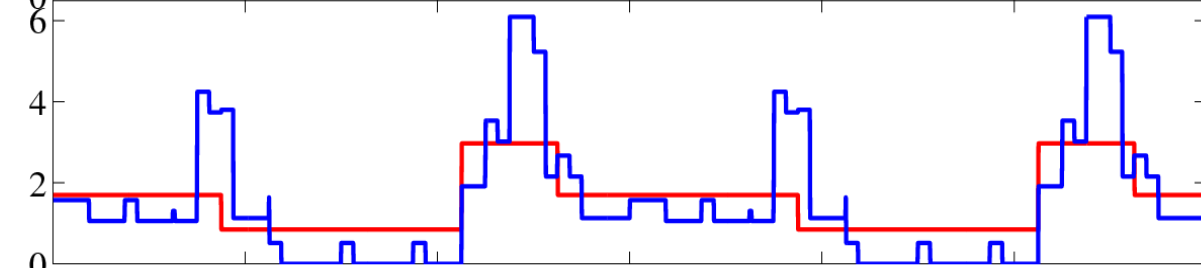

Relative Humidity (%)

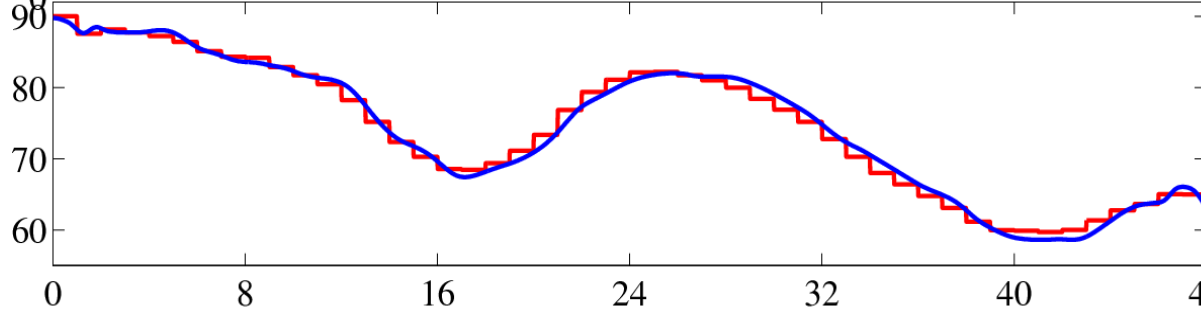

Time (h)

# Wholesale Prices Passed Thru to Households

- Retail prices charged to retail energy customers on day D given by DAM LMPs plus profit markup determined on D-1
- Retail prices for day D conveyed by LSEs to households by evening of day D-1

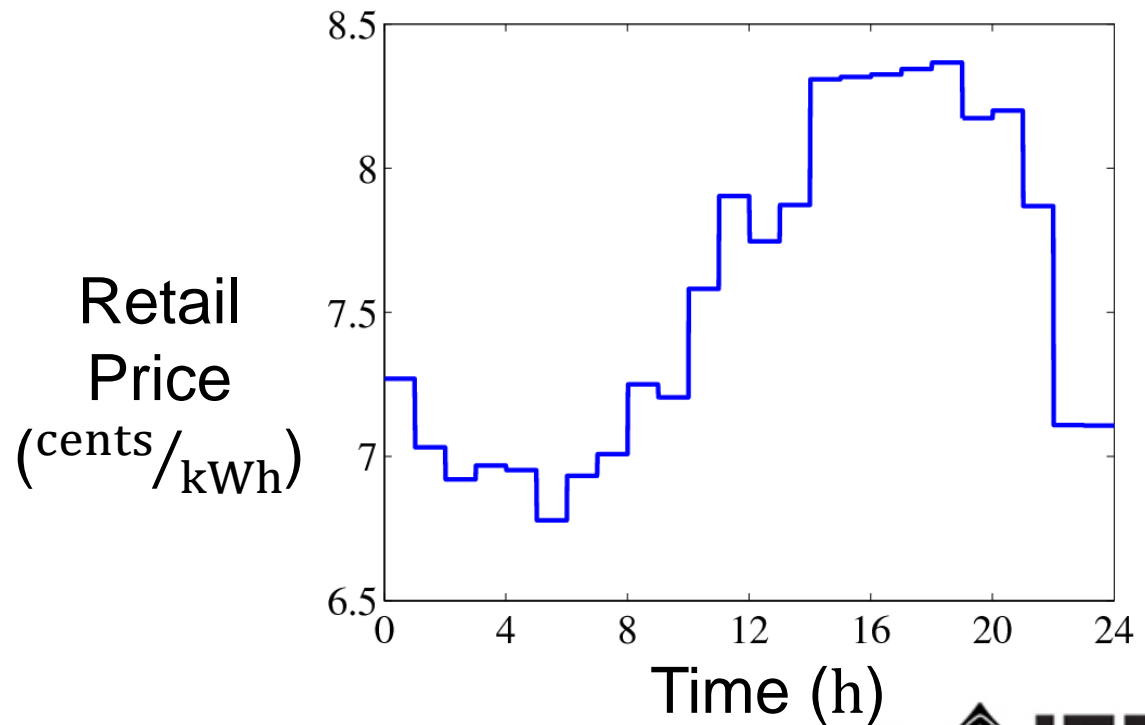

# Attributes of Household Residents

- Comfort function (utils) measuring household resident's comfort level as a function of inside air temperature
- Bliss temperature = Inside air temperature providing highest comfort to the at-home resident
- $\alpha$  = Parameter (utils/\$) measuring resident's trade-off between thermal comfort and electricity cost (higher  $\alpha$   $\rightarrow$  higher concern for cost relative to comfort)
- Home-occupancy times of the household resident

# Illustrative Results: Resident always home

Higher  $\alpha$  = Higher concern for cost; Bliss temp = 74°F

Inside Air  
Temperature  
(°F)

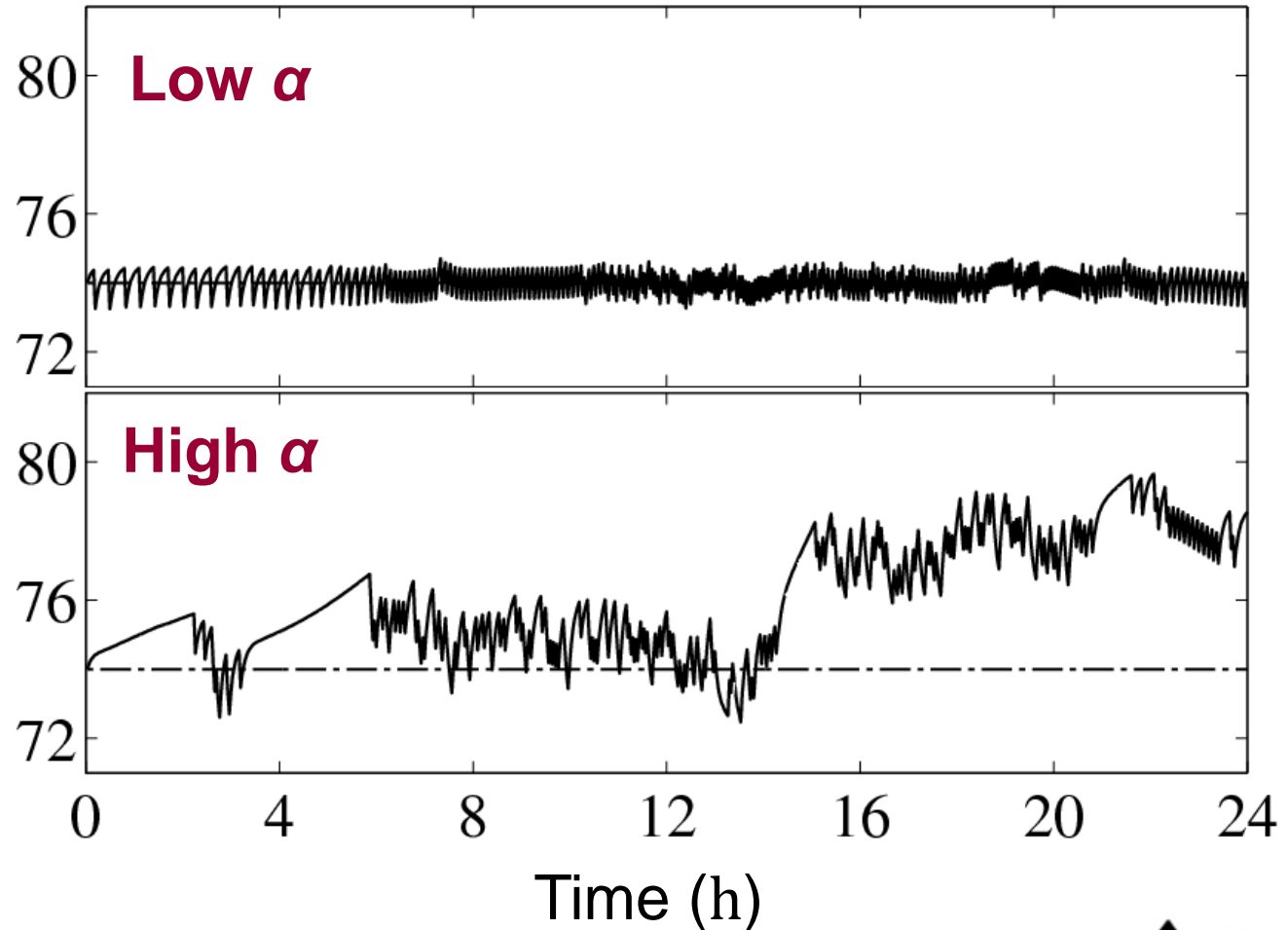

# Resident away from home 8am - 5pm

Higher  $\alpha$  = Higher concern for cost; Bliss temp = 74°F

Inside Air Temperature (°F)

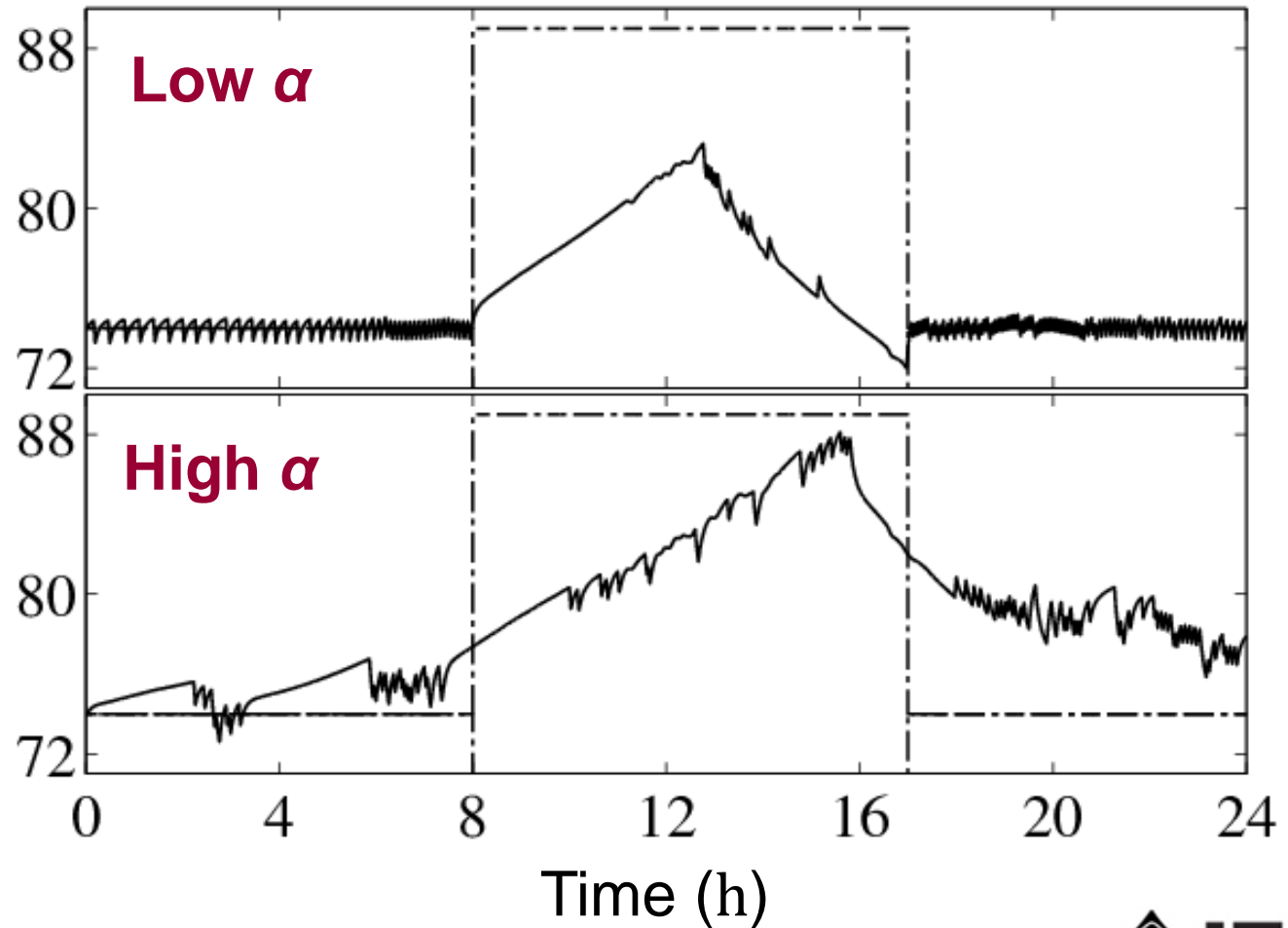

# From single-household load to aggregated bus load

## Non-Price-Responsive Load

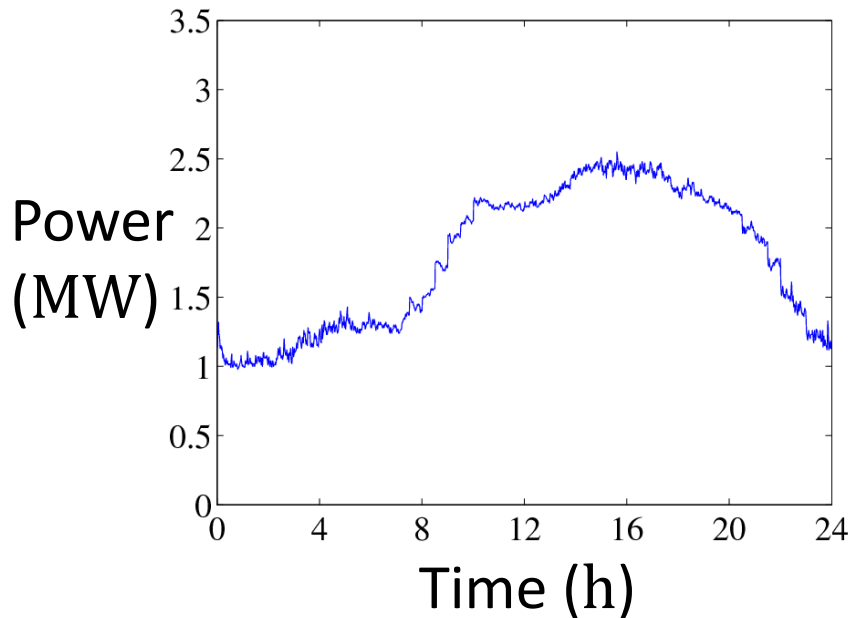

## Intelligent A/C Load

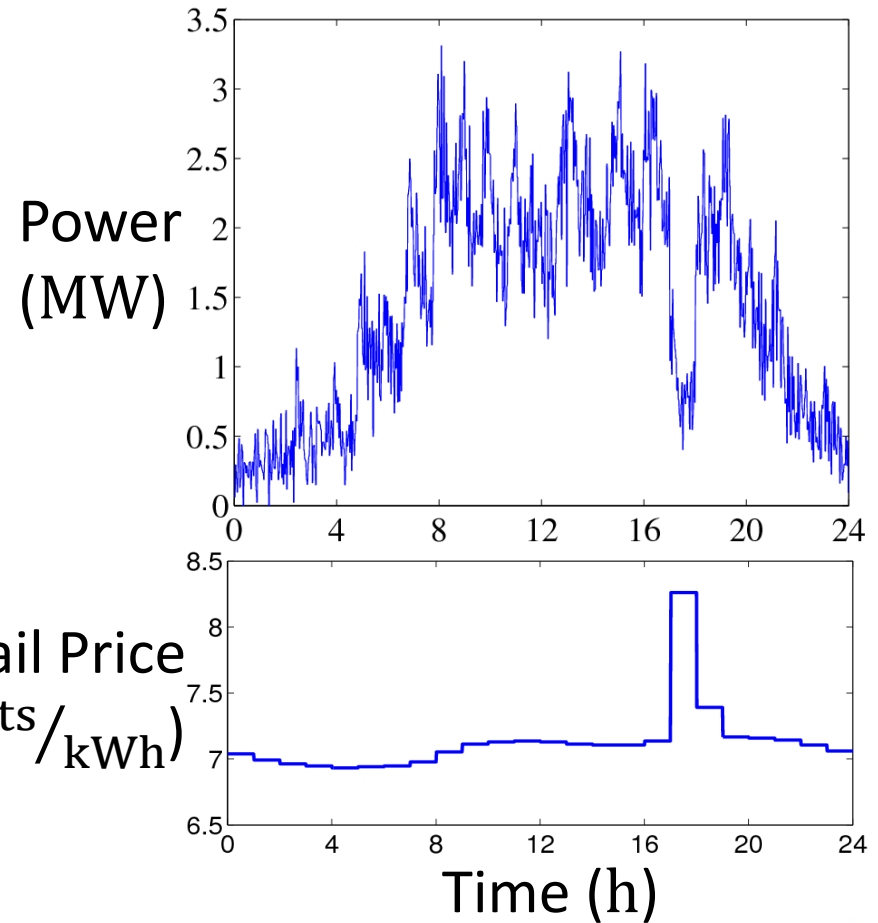

# A/C Case Study Specifications

- Single Distribution Feeder
  - Many types of houses
  - Many types of household residents (differing  $\alpha$  values)
  
- Wholesale Power System
  - 5 buses and 6 lines
  - 3 LSEs with conventional loads (no price sensitivity)
  - 1 LSE with price-sensitive-load customers
  - 5 GenCos



# A/C Case Study Specifications...Continued

- Exogenously given state vector for each day
  - Temperature profile
  - Conventional load profiles
  - Other forcing terms
  
- LSE DAM demand bid method
  - Day D-1 actual load -> Day-D demand bid

# Illustrative Results for a Single Day

## Retail Prices/Temp → Retail Total Load Profile

Retail Price

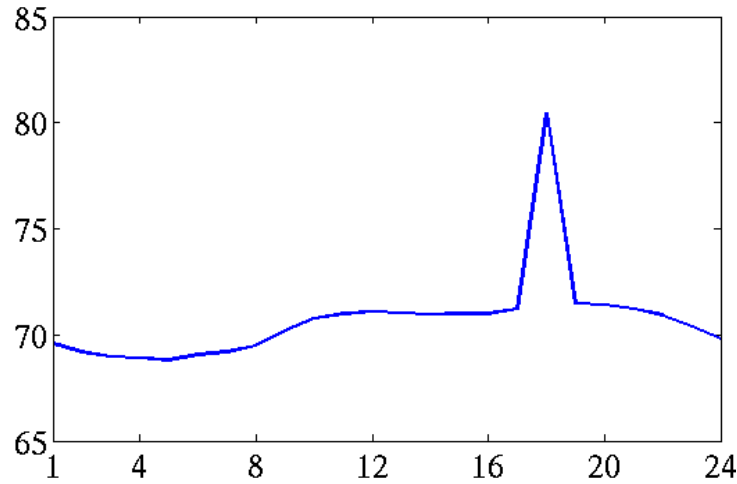

Retail Total Load

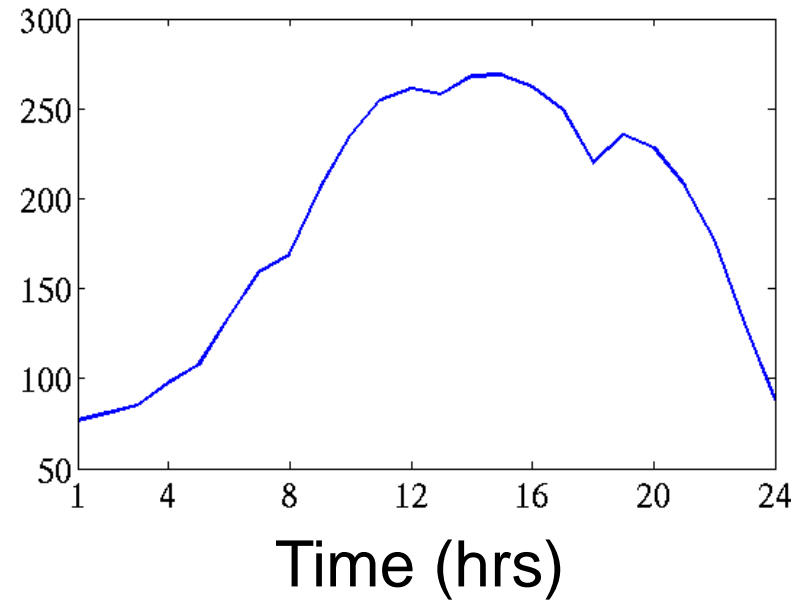

Outside Temp

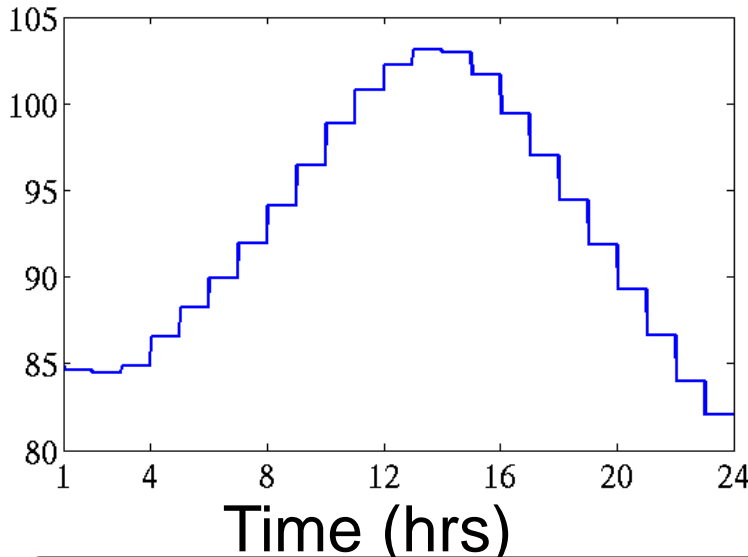

Time (hrs)

# Illustrative results for 50 Days (Peak Hour 18)

Retail Price  $\rightarrow$  Retail Total Load

## Retail Price

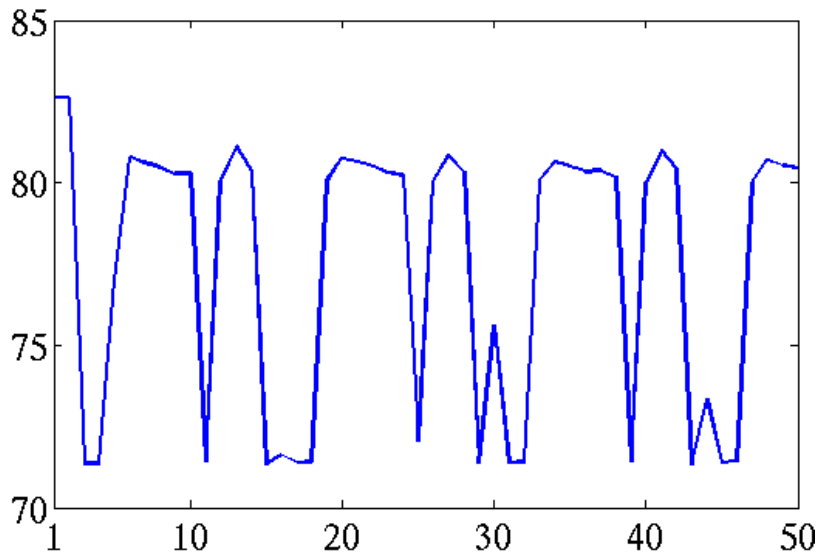

Days

## Retail Total Load

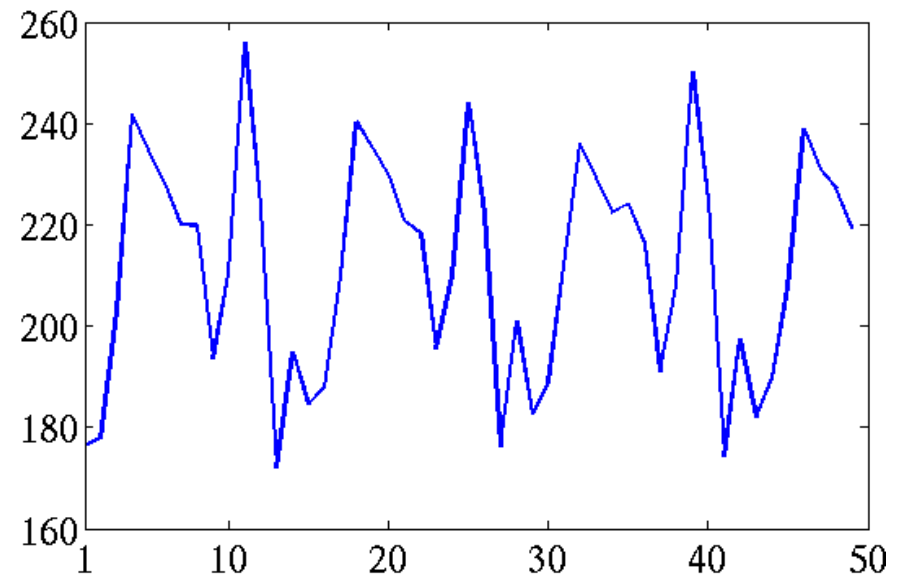

Days

# Illustrative Results for 50 Days

## Superimposed retail total load profiles

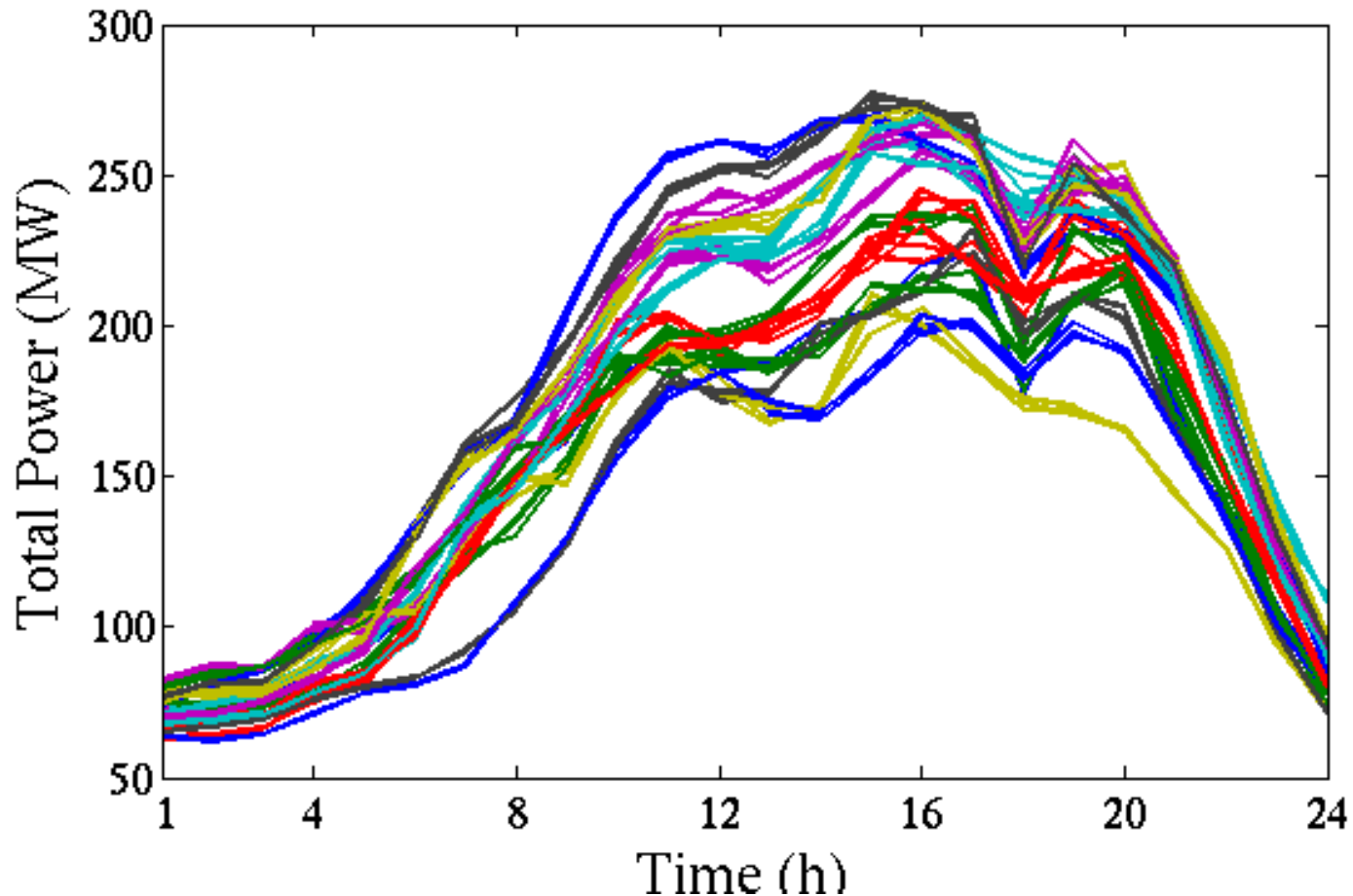

# Ongoing Research

- Further investigation of IRW feedback loop
  - Price-responsive demand
  - Penetration of wind power
- More realistic case studies
  - Use of a High Performance Computing (HPC) cluster to simulate multiple distribution feeders
  - Improved LSE load forecasting methods

# IRW Project Publications

- Auswin George Thomas, Pedram Jahangiri, Di Wu, Chengri Cai, Huan Zhao, Dionysios C. Aliprantis, and Leigh Tesfatsion, “Intelligent Residential Air-Conditioning System with Smart-Grid Functionality,” ***IEEE Transactions on Smart Grid***, Vol. 3, No. 4, December 2012, 2240-2251.
- Auswin George Thomas, Chengrui Cai, Dionysios C. Aliprantis, and Leigh Tesfatsion, “Effects of Price-Responsive Residential Demand on Retail and Wholesale Power Market Operations”, ***Proceedings of the IEEE Power and Energy Society General Meeting***, San Diego, CA, July 22-26, 2012
- Chengrui Cai, Pedram Jahangiri, Auswin George Thomas, Huan Zhao, Dionysios C. Aliprantis, and Leigh Tesfatsion, “Agent-Based Simulation of Distribution Systems with High Penetration of Photovoltaic Generation”, ***Proceedings of the IEEE Power and Energy Society General Meeting***, Detroit, MI, 2011
- Huan Zhao, Auswin George Thomas, Pedram Jahangiri, Chengrui Cai, Leigh Tesfatsion, and Dionysios C. Aliprantis, “Two Settlement Electric Power Markets with Dynamic-Price Customers,” ***Proceedings of the IEEE Power and Energy Society General Meeting***, Detroit, MI, 2011
- Auswin George Thomas, “Residential air-conditioning system with smart-grid functionality,” ***M.S. Thesis***, Iowa State U., 2012

# On-Line Resources

## ❑ IRW Project Homepage

[www.econ.iastate.edu/tesfatsi/IRWProjectHome.htm](http://www.econ.iastate.edu/tesfatsi/IRWProjectHome.htm)

## ❑ AMES Test Bed Homepage (Code/Manuals/Publications)

[www.econ.iastate.edu/tesfatsi/AMESMarketHome.htm](http://www.econ.iastate.edu/tesfatsi/AMESMarketHome.htm)

## ❑ Agent-Based Electricity Market Research

[www.econ.iastate.edu/tesfatsi/aelect.htm](http://www.econ.iastate.edu/tesfatsi/aelect.htm)

## ❑ Open Source Software for Electricity Market Research, Teaching, and Training

[www.econ.iastate.edu/tesfatsi/electricoss.htm](http://www.econ.iastate.edu/tesfatsi/electricoss.htm)